

FILTER NK 124

THE FILTER IS SUITABLE FOR:

Automatic water softeners **GIX5-GIX8 GIX12**
with water connection 3/4"G.

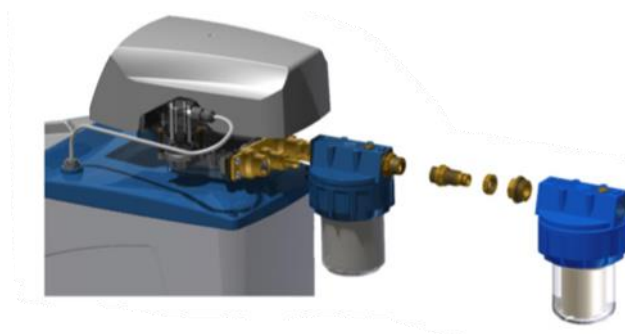

THE FILTER IS COMPOSED BY:

- 1 Head with pressure loss screw
- 1 Locking ring
- 1 O-ring
- 1 Glass of 5 inches
- 1 Cartridge
- Kit water network connection

TECHNICAL FEATURES:

Coupling 3/4"G

Filtration capacity with:

- The wound cartridge 50 micron
- The carbon block cartridge 5 micron

INFEEED WATER FEATURES:

- Drinkable water
- Temperature: min 8 °C - max 25°C
- Pressure: min 2 bar - max 8 bar

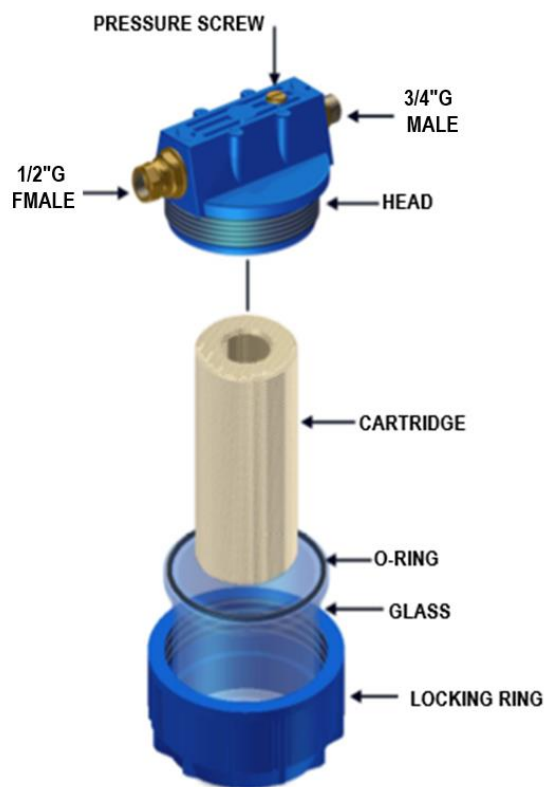

CONNECTION SCHEME BETWEEN THE FILTER AND THE GIX MODEL SOFTENER

1) Put on some teflon on the thread 3/4" G of the tap.

2) Screw the fitting on the tap and the locking nut on the fitting.

3) Screw the filter head into the fitting and locking nut to secure it.

4-5) Insert the cartridge into the glass making sure the o-ring is positioned correctly.

Screw the filter head onto the ring using the filter key.

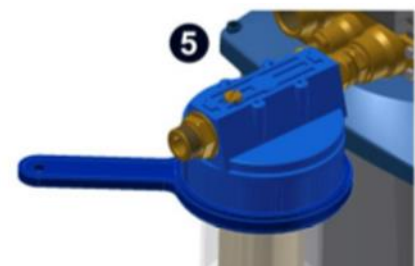
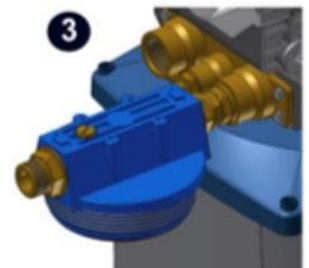
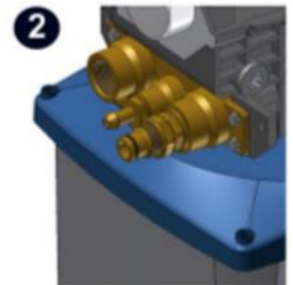
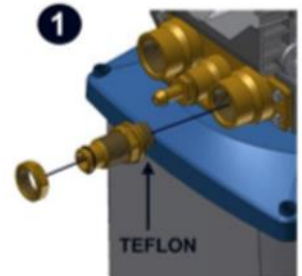

THE PACKAGE CONTAINS:

- 1 Complete filter
- 1 Replacement cartridge
- 1 Filter key
- 1 Fitting Series for net water connection

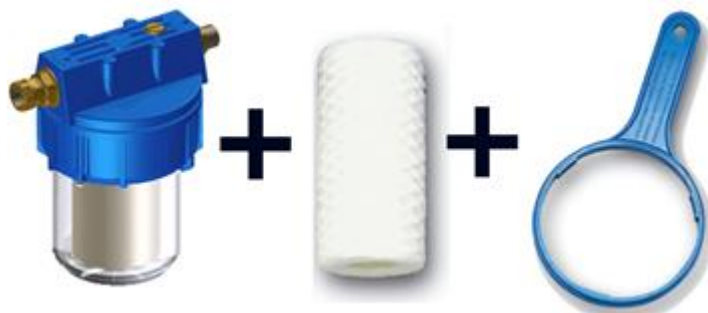

MAINTENANCE:

Maintenance simply involves replacing the cartridge. The operation must be performed at least once every 6 months or every cartridge looks dirty.

NK124C FILTER WITH CARBON BLOCK CARTRIDGE



The filter is available with activated carbon cartridge which allows to remove unpleasant smells and tastes. It guarantees greater retaining even the particles of a size of 5 micron.

PRODUCT CODE:

- **NK124**
Complete filter with wound polypropylene cartridge.
- **NK124C**
Complete filter with carbon block cartridge.

